



RECOMMENDED INSTALLATION GUIDELINES

WellBAC™

HARDBACK & CUSHION BACKED
CARPET TILES

Creating amazing spaces

Ontera
A MILLIKEN COMPANY

Date of Issue - 12th July 2018
(This document supersedes all previous versions)

WELLBAC™ CARPET TILES

RECOMMENDED INSTALLATION GUIDELINES

Notice

Dealer and installer must inspect carpet tiles prior to installation. Ontera WILL NOT be responsible for visible defects after the carpet tiles have been installed.

General

Carpet tiles should be installed using only the recommended Pressure Sensitive Adhesives to allow easy removal and reinstallation. The installer should review these instructions before starting the installation.

Floor Preparation

- The floor should be prepared as per the current version of AS/NZS 2455.1:2007 and these instructions. Please note if there is a discrepancy between the AS/NZS Standard and these instructions, these instructions should be followed.
- The carpet/carpet tiles are to be installed in accordance with AS/NZS 2455.1:2007 & AS/NZS 2455.2:2007
- Concrete floors may be primed or a moisture barrier applied where the subfloor is excessively porous, dusty or evidence of moisture exists. (Please refer to primer/moisture barrier/levelling compound/adhesive manufacturer's for further information and product recommendations.)
- The floor must be dry, smooth, sound, clean, and free from dust and/or all foreign matter such as grease, paint, wax, oil, dirt, old adhesives/floor prep etc. Cracks, holes and depressions must be filled with appropriate floor patching compound. Ensure the floor is thoroughly vacuumed (please refer to levelling compound manufacturers for detailed recommendations).
- In regards to the smoothness and planeness of the subfloor, the following conditions must be met as per AS/NZS 2455.1.2007.
 - Plane (surface) - Of a condition such that when a straightedge 3 metres long is placed on the surface at any position, no part is more than 3mm above or below the straightedge
 - Smoothness (surface) - Of a condition such that, when a straightedge 150mm long is placed on the surface at any position, no part of it is to be more than 1mm below the straightedge.
- The surface of the concrete subfloor must be porous and cannot be burnished or overly power trowelled. Burnished or overly power trowelled surfaces leave an impermeable surface that the primers and adhesives cannot bond with. We recommend that a water drop test is done on the surface of the subfloor. This is where droplets of water approximately the size of a 50-cent piece are placed on the surface of the slab. If the water beads on the surface the slab, the surface is not suitable for the recommended adhesives and must be mechanically prepared to ensure the surface is porous. The water should penetrate the slab within 60-90 seconds for it to be deemed suitable for the primer/adhesive/levelling compound/moisture barrier application
- Protruding objects must be removed and sealed.
- Floor temperature should be a minimum of 16°C and the modules should be conditioned at 16°C minimum for 24 hours prior to installing. Concrete pH should be between 7- 9 or as recommended by the adhesive/screed manufacturer's recommendations. The relative humidity (RH) should not exceed 75% as per AS/NZS 2455.1:2007 or as recommended by the adhesive/screed manufacturer. DO NOT proceed if the RH and pH are above the allowable maximum level.

Moisture testing of subfloors

Concrete subfloors

- All concrete subfloors are to be tested for Relative Humidity (RH) and Alkalinity (pH) prior to the installation commencing.
- RH testing is to be done via the current version of ASTM F2170 RH in-situ probe test method and pH testing is to be done in accordance with the current version of ASTM F710 using either a pH meter or pH papers. Always follow the RH & pH testing equipment manufacturer's installation instructions when undertaken testing.
- Site conditions for RH testing (temperature and RH) must be constant in the area being tested and must reflect in-service conditions.
- The requirements of the adhesive manufacturer are to be followed in regards to the maximum RH and pH of the subfloor however if adhesive manufacturer does not state any requirements in their instructions then the default readings are to be not more than 75% RH and the pH is between 7-9. For any readings outside of those noted here, moisture abatement steps MUST be taken in accordance with the adhesive manufacturer's recommendations.

Timber subfloors

- All timber subfloors are to comply with the requirements for timber flooring in the relevant Australian/New Zealand Standard.
- The moisture content can be determined with an electrical resistance type meter and generally should be between 10-15% however always follow the adhesive manufacturer's recommendations.
- Where new or existing timber, plywood or particle board subfloors are to be used as the substrate, worn, rough, cupped, warped or damaged surfaces shall be sand or filled and must retain structural integrity. In some instances, it may require re-nailing of the old subfloor or repair it by replacing the worn and unsound sections.
- Ontera recommend that on all timber subfloors an underlay (as noted in AS 1884:2012) is to be installed in accordance with the manufacturer's instructions and site conditions.
- The moisture content of the subfloor must be tested prior to an underlay being installed as Hardboard, MDF and plywood underlays may react with the high moisture content of a timber subfloor.

Adhesion Bond Test

- Ontera recommend that an adhesive bond test is undertaken, if there are any issues with the subfloor or unknown contaminants were previously on the subfloor, to ensure the compatibility of the adhesive to the subfloor.
- This test should be performed for a duration of at least a week to give the adhesive time to react with any contaminants in the subfloor with a minimum of 4 tiles being installed.
- After a week remove the carpet tiles and the adhesive should remain bonded to the subfloor.
- If the adhesive comes up with the carpet tiles there may be an issue with the subfloor and we recommend contacting the adhesive manufacturer.

Conditioning

Before commencing installation, the carpet tiles and all other materials being installed must be allowed to condition within or near the installation area for a period not less than 24 hours or until the products have achieved an ambient room temperature range of 16°C to 28°C.

Areas being installed must have the HVAC system running or have other temperature control methods in place for at least 48 hours prior to the installation commencing, so that the ambient temperature is 16°C or above and the ambient RH is between 40-60%. Heating devices such as electric radiant heat or electric heat blowers shall be used. If LPG gas blowers are used for raising ambient room temperature, an ambient relative humidity of no more than 60% shall be maintained.

The areas to be installed must have the HVAC or other temperature control devices operating during the installation and for a minimum 48 hours thereafter.

It is critical that the carpet tiles are only installed in a fully enclosed environment with all walls, floors, doors and windows installed. Ontera will not be responsible for carpet tiles that are installed where the outside ambient conditions could affect the installation.

Adhesive

- Adhesive should be a water based pressure sensitive acrylic product.
- A full spread of adhesive must be applied to the subfloor at all times.
- Your adhesive supplier will recommend how to apply the adhesive eg roller or notched trowel
- A low VOC emitting adhesive is recommended for minimal environmental impact during installation.
- **Consult your adhesive company for their recommendations, application rates and warranties.**

* Please refer to Ontera’s Adhesive Product Suggestion document for further information.

Ontera is not responsible for product failure of any kind if the floor preparation, installation guidelines and tests above are not adhered to, in which case the product warranty may be voided.

BACKING TYPE	RECOMMENDED ADHESIVE	ADHESIVE SUPPLIER
WellBAC™ Function	Ontera Non-Reactive Standard Adhesive	Ontera
WellBAC™ Comfort	Ontera Non-Reactive Standard Adhesive	Ontera
WellBAC™ Comfort Plus	Ontera Non-Reactive Standard Adhesive	Ontera
Note: The following adhesives are also approved for use with all Ontera WellBAC™ carpet tiles		
	Intafloors Ultra Stix	Intafloors Trade Depot
	Mapei Ultrabond Eco Tack	Mapei
	RLA GS300 Green Solutions	RLA Polymers
	Roberts 656 PSA	RLA Polymers

Like to install carpet from 90 days after a new concrete pour?

Ontera’s Non-Reactive Standard Adhesive is specifically formulated for use with all Ontera’s WellBAC™ carpet tiles. When combined with Ontera WellBAC™ cushion tiles it eliminates the need for grinding old adhesives and allows installation from 90 days after a new concrete pour.

Refer to page 8 for Ontera’s Site-Related Solutions offer.

Storage & Handling of carpet tiles

- Proper storage and handling practices must be followed at all times.
- Carpet tiles must not be double stacked or top loaded at any time.
- Remove stretch wrapping immediately upon receipt of the delivery.
- Store in a dry location
- Install the carpet tiles within 2 weeks of receipt

INSTALLATION INSTRUCTIONS

Installation

- A full spread of adhesive is to be applied to the subfloor at all times following the adhesive manufacturer's guidelines in regards to the applicator type, application rates, when primers are to be used, RH & pH requirements, etc.
- Allow compound to dry, at which stage the adhesive will become clear and tacky. This tack remains indefinitely providing the compound remains free from dust. A releasable compound is ready when it does not transfer to a finger or module place on it.
- The location of the starting point in any modular installation is assigned by the installer to maximise perimeter and cut module size. It can be anywhere within the room but is usually located as close to the true centre of the room as possible. When the installer has isolated the point which gives the best perimeter and cut modules he should strike two working chalklines as follows:
 - Line one is snapped parallel to one major wall (usually an outside wall) running through the starting point.
 - Line two is constructed from the starting point at 90 to line one using a 3-4-5, 6-8-10, 9-12-15, 12-16-20, 15-20-25 or 30- 40-50 triangle depending on room size. Always use the largest triangle possible to minimise error. A small error, especially in large areas, can result in serious installation difficulty. (See diagram below for a step-by-step procedure for constructing chalkline #2).

Construct Chalkline #2 as follows:

1. Measure EXACTLY 3 metres from the starting point along chalkline #1.
2. Measure EXACTLY 4 metres from the starting point perpendicular to line #1 approximately 10-12 cm long as indicated by Line "B".
3. Measure EXACTLY 5 metres diagonally from point 'A' to line 'B' as indicated.
4. That point on Line 'B' exactly 5 metres from point 'A' when

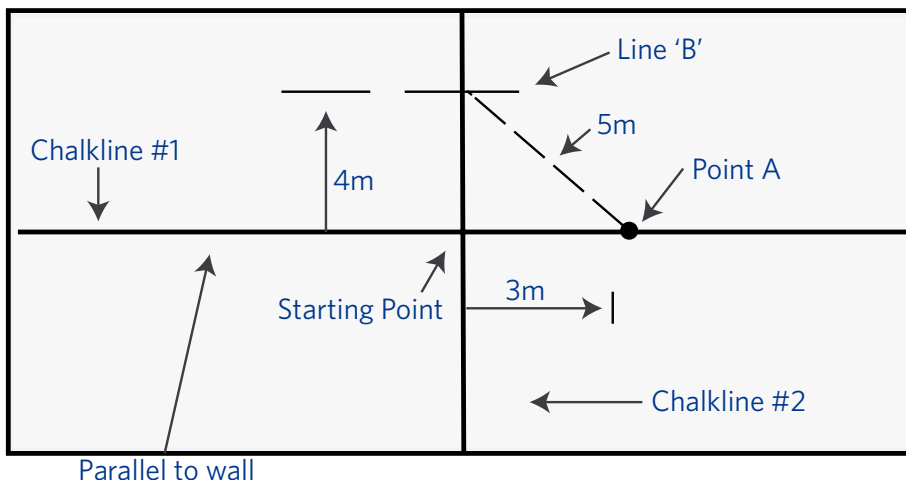

connected with the starting point gives a line exactly 90° to chalkline #1. This line should be extended to entire length of the area as indicated.

- On particularly large or complex jobs, the use of a transit to establish the above lines can prove very helpful.
- The installer should work in a 'pyramid' or 'stairstep' manner from the starting point along both chalklines as shown in the following diagram:

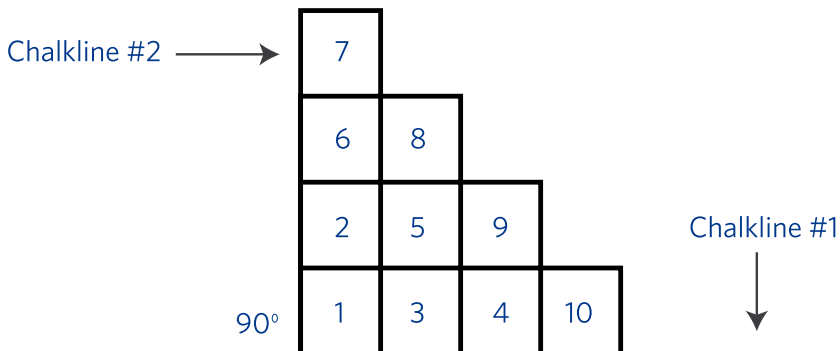

- The pyramid technique gives three alignment check points on each tile placed. Careful attention should be paid to edge and corner alignment. Modules out of alignment by more than 2mm should not be installed. Some 'Wandering' of edges due to unevenness in the floor is unavoidable. This will be gradual and tend to come and go and, as such, is not cause for alarm. If the edges become misaligned and this misalignment continues to increase, this indicates an out of square condition. The problem should be immediately determined and corrected.
- Always SLIDE each module into position from the side to prevent trapped yarn.
- Modules should be installed firmly but not compressed. Too little pressure may allow modules to shift or gap on the floor with use. Progressively check tightness during installation by measuring 11 full modules (10 joints). When measuring 11 modules the measurement should not be less than 5,505mm or the modules may peak or buckle.
- CHECK MEASURING is essential for all products but is particularly important to ensure the correct tightness of tufted products.
- Arrows are printed on the back of each module indicating pile direction. This allows the customer to choose the method of installation preferred - Linear, Quarter Turn or Random Lay.
- The Parallel Cutting Technique, marked from the face and cut from the back, expedites installation in recessed areas.

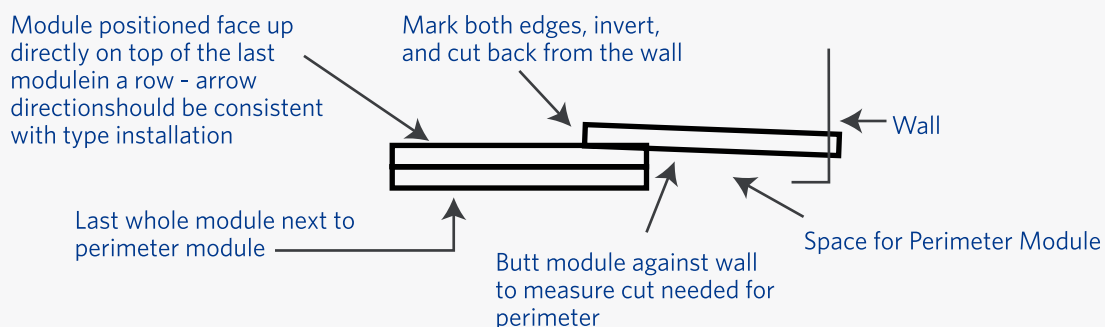

- Plywood or masonite should be positioned on modules when heavy furniture or supplies are moved throughout the installation.
- The recommended casters for desk chairs should have a tread width of 20mm to 25mm, and a wheel diameter of 50mm to 65mm tapered. Hard polyolefin composition is recommended.

For more detailed information, contact Ontera Modular Carpets Technical Services.

Adhesive free installation using Traction™ Tape

Traction Tape™ by Ontera is a pressure sensitive strip fixing system with inbuilt adhesive properties which can be used to install modular carpet (carpet tiles) without the application of conventional liquid adhesive. Traction Tape™ is supplied in rolls of 300 lineal metres, 75mm wide, which is sufficient to install approximately 136m² of 500mm x 500mm or 179m² of 600 x 600mm square carpet tile.

The floor should be prepared as prescribed in AS/NZS 2455.1:2007 and should be free of all foreign matter, grease, paint, wax, oil, dirt and non-compatible adhesives. The positioning of the carpet tiles should be as detailed in the installation instructions section in AS/NZS 2455.2:2007.

The location of the starting point in any modular installation should be assigned by the installer to maximise the perimeter and cut module size. It can be anywhere but is usually located as close to the centre of the room as possible. The installer should then strike two working chalk lines as follows:

Chalkline 1 is snapped parallel to a major wall (usually an outside wall) running through the starting point.

Chalkline 2 is constructed from the starting point at 90° to chalk line 1 using a 3-4-5 triangle as shown in the following diagram:

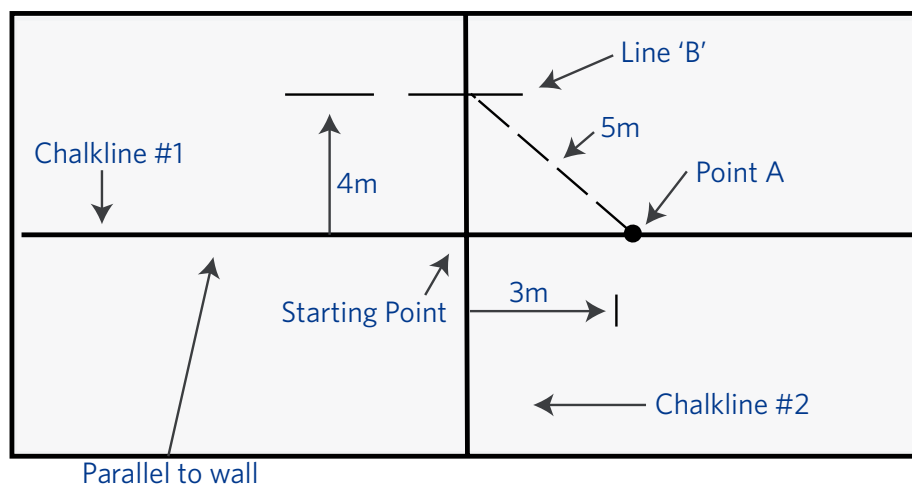

Once this has been completed roll the tape using a roller that is also supplied, either

i) along the approximate centre, or

ii) at the edge of a row of two adjacent tiles in one direction only as shown in the diagram below. Once the strip has been positioned simply lay the tiles using the same method detailed in the installation guidelines. It is recommended that the original chalkline is used to position the first roll of tape, with the additional tape being rolled parallel at 500mm.

Option #1

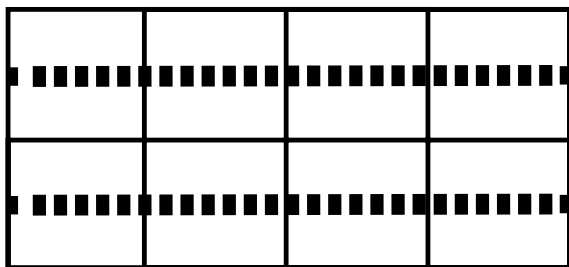

Option #2

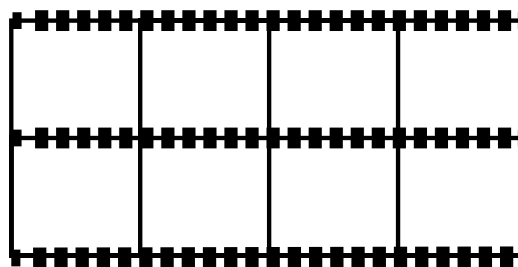

Installation instructions for stairs

Ontera carpet tiles are suitable for use on stairs only if fitted with nosings. For more detailed instructions, please refer to the nosing manufacturers installation instructions for use with carpet tiles.

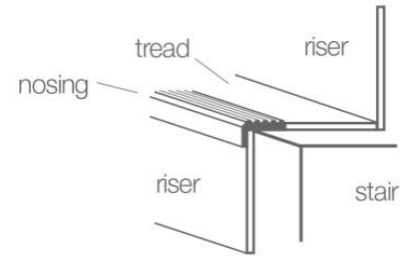

- Measure and cut carpet tiles for riser to size and then install to finish level with stair tread.
- Suitable PS Adhesives must be applied to both the riser and the tile backing, allowing the tile to tack up prior to placement of carpet tile.
- The stair tread nosing must be fully adhered on the tread of the step, do not adhere the inside front of the nosing to the riser.
- Measure and cut carpet tiles for tread to size and then install to finish level with stair nosing and butting to riser.

* Please refer to the stair tread & nosing manufacturer's installation guidelines for detailed information on stair installation with carpet tiles.

Maintenance recommendation

Ontera modular carpets are constructed with a higher pile density than most conventional carpets, thus providing the highest possible long term wear capabilities. However, this also means that the maintenance recommendations detailed in the Ontera Care and Maintenance Guide should be adhered to for optimum appearance retention.

Please refer to Ontera's Care and Maintenance guide for information on cleaning maintenance.

Cut Pile Products

- During the manufacture of Ontera's cut pile carpet there is always a small amount of short fibre which is not removed from the pile. (This is common to all cut-pile carpets).
- During storage and transportation, we have found that in most cases the tiles on the bottom of pallet can suffer from a certain amount of flattening under the 500kg pressure.
- To ensure that the short fibres are removed and the effects of flattening are reduced, it is necessary that after installation this carpet is given a pile lift and vacuum.
- This will ensure customer satisfaction, both initially and long term.

Ontera's Site-Related Solutions - Saves time & money

New construction:

Like to install from 90 days after a new concrete pour?

With Ontera's Non-Reactive Standard Adhesive and Ontera cushion backed tiles you can install from 90 days after a new pour and be fully warranted to withstand moisture from slabs for the lifetime of the original carpet installation.

Refer to the Ontera website for complete Site Related Solutions product offer and Warranty details.

Renovation:

Like to eliminate floor preparation and avoid moisture testing?

With Ontera's Non-Reactive Standard Adhesive and Ontera cushion backed tiles you can install without the need to remove old adhesives and with no moisture testing. Both carpet and adhesive are fully warranted under virtually every circumstance.

Refer to the Ontera website for complete Site Related Solutions product offer and Warranty details.

Recommended installation method(s)

Tile Installation:



Monolithic



Quarter-turn



Brick Ashlar



Ashlar



Random Lay

NB: Please consult with key stakeholders (eg architect, building owner) before confirming installation method.

COLLECTION	METHOD	COLLECTION	METHOD
Arctic Survey	Plank Installation - see below methods	Karona 2 Lightning, Blizzard	Monolithic Lay, Quarter Turn
Amplifier	Beats, Echo Treble: Monolithic Beats, Echo, Treble, Octave: Quarter Turn Octave: Brick Ashlar Echo: Random	Karona 2 Eclipse, Spectrum	Monolithic Lay
180°	Monolithic Lay, Quarter Turn, Random Lay, Ashlar	Momentum Figment - Mythology	Monolithic Lay
Colour Connect	Skor: Monolithic Lay, Brick Ashlar Linx: Monolithic Lay	Naturally Drawn	Ashlar
Colour Compositions	Plank Installation - see below methods	Nordic Stories	Monolithic Lay
Common Thread	Monolithic Lay, Ashlar	Patina Vibes	Monolithic Lay, Ashlar
Consequence 2.0	Monolithic Lay (Sequel only), Vertical Ashlar	Quadrus	Monolithic Lay
Danxia	Monolithic Lay, Quarter Turn, Random Lay, Ashlar	Sendal	Monolithic Lay
Exceed	Action, Buzz, Speed: Monolithic Lay Energy: Brick Ashlar	Sepio	Monolithic Lay
Envisions	Monolithic Lay	Sound & Fury	Monolithic Lay, Quarter Turn, Ashlar
Fixate	Monolithic Lay, Quarter Turn, Ashlar	Southern Analog	Monolithic Lay, Quarter Turn, Random Lay, Ashlar
Formwork	Monolithic Lay	Ultra 2	Monolithic Lay, Quarter Turn, Random Lay, Ashlar
Havana	Monolithic Lay	Variations Needlepoint	Quarter Turn
		Whale Song	Brick Ashlar, Ashlar

Plank Installation Ideas:



Ashlar Half Drop



Ashlar Random



Herringbone



Boxed



Basketweave (25cm x 1m)

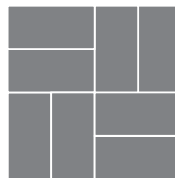

Basketweave (50cm x 1m)

Ontera Customer Service: Australia: +61 (02) 8838 2500 • New Zealand: 0800 668372
 onteracustomerservice@milliken.com www.ontera.com.au © 2017 Milliken & Company

Ontera
 A MILLIKEN COMPANY